

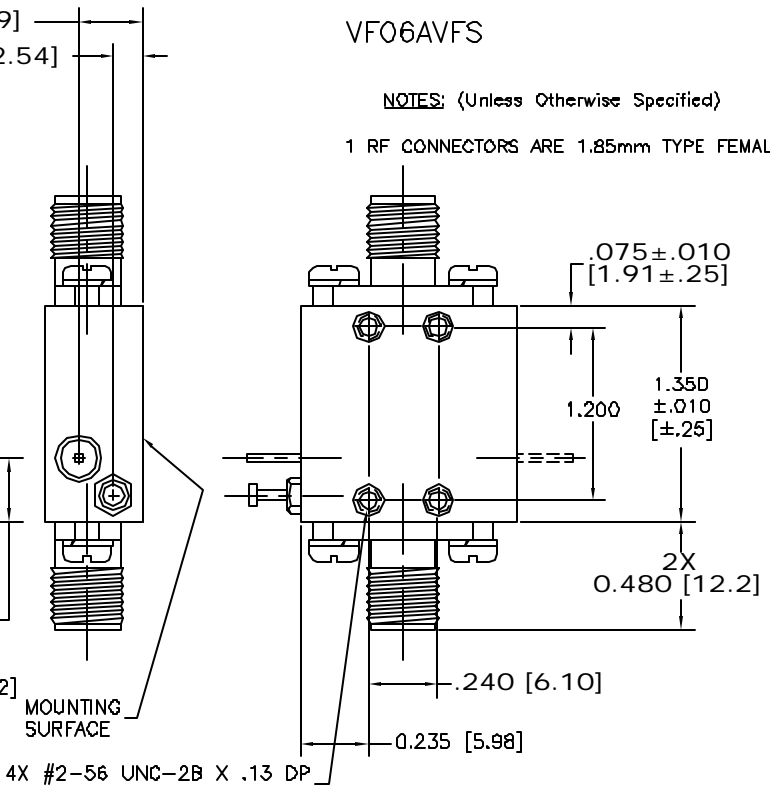

VFO6AVFS

NOTES: (Unless Otherwise Specified)

1 RF CONNECTORS ARE 1.85mm TYPE FEMALE.

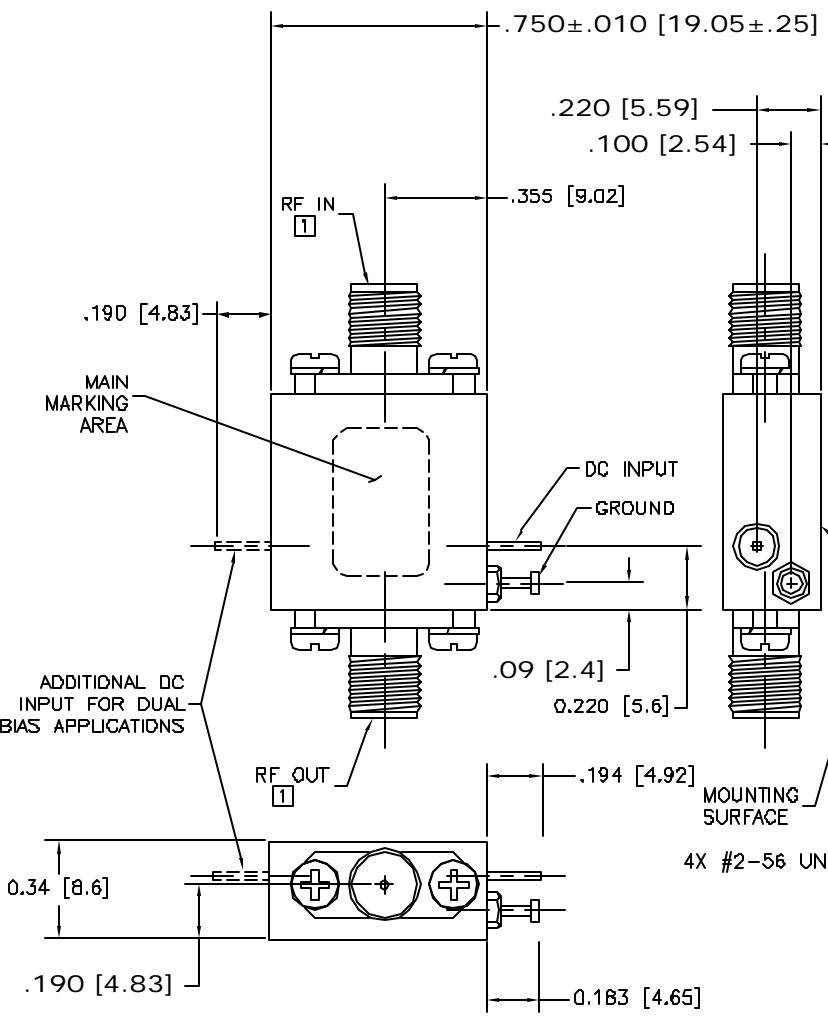

UNLESS OTHERWISE SPECIFIED
 TOLERANCES ARE IN:
 INCHES [mm]
 XX ± .02 [±.5]
 XXX ± .005 [±.13]